

**DESCRIPTION**

The **HLA-9** is a hybrid integration of a nine element J-array loudspeaker and a dipole directional low frequency loudspeaker. The J-array portion contains nine 3.5" mid-frequency drivers and nine ribbon high frequency drivers. The low frequency portion incorporates two 12" high output low frequency drivers in a dipole configuration to extend vertical LF control.

It has been preconfigured in an asymmetrical 35°V by 120°H coverage pattern with vertical directivity to 175 Hz, and low frequency response to 50 Hz. A single HLA-9 can provide full range coverage of both the front row and seats as far as 75 feet away with exceptional clarity and detail.

**KEY FEATURES:**

- asymmetrical 35° V x 120° H coverage
- vertical control to 175 Hz
- -3 dB low frequency response 50 Hz
- effective projection to 75 feet

**APPLICATIONS:**

- churches
- lecture halls
- presentation spaces
- performing arts centers



**NOMINAL DATA**

Frequency Response	50 Hz to 20 kHz, ± 3 dB
Sensitivity	98 dB @ 2.83V / 1M
Impedance	Mid-Hi – 8Ω / LF – 4Ω
Power Handling	M/H: 750 W long-term (AES-2) LF: 2000 W long-term (AES-2)
Maximum Output	121 dB long-term, 127 dB peak
Nominal Coverage	120° H x 35° V
Dimensions	height: 37.65" / 956 mm width: 15.38" / 390 mm depth: 15.38" / 390 mm
Net Weight	82 lbs / 37.3 kg
Shipping Weight	91 lbs / 41.4 kg

**DESCRIPTIVE DATA**

System Configuration	Biamped hybrid integration of a curvilinear M/H line array and a low frequency dipole
Components & Loading	9 x 3.5" MF 9 x 3" ribbon HF 2 x 12" LF drivers
Recommended Crossover	4 <sup>th</sup> order Linkwitz-Riley @ 350 Hz
Recommended High-Pass Filter	4 <sup>th</sup> order Butterworth @ 40 Hz
Enclosure Type	Curvilinear array: sealed enclosure Dipole LF: tuned reflex enclosure
Enclosure Material	Steel, Aluminum & Baltic Birch Plywood
Finish	White or Black (custom colors available)
Connectors	NL4, & (2) dual binding head screws
Suspension Hardware	(2) 3/8-16 threaded points on each side; steel yoke included
Grille	Painted perforated steel (fabric-wrap available as an option)

**DIMENSIONAL DRAWINGS**

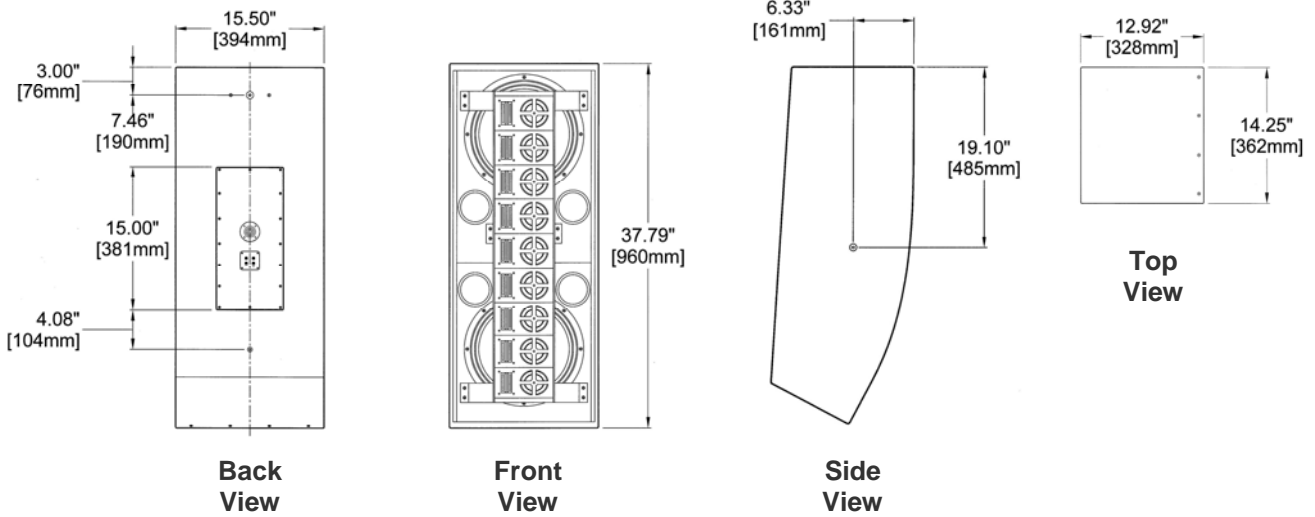

**INCLUDED HARDWARE**

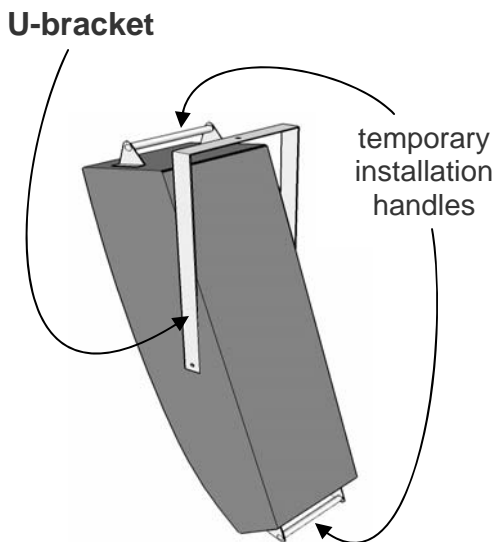

**OPTIONAL ACCESSORIES**

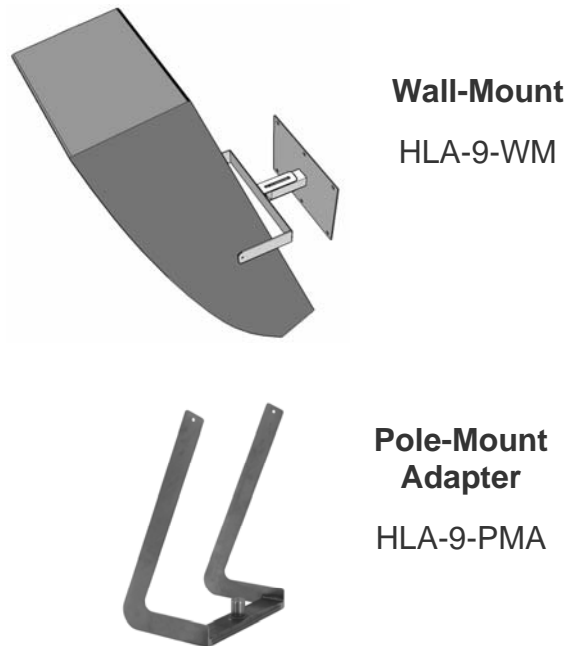

Powered HLA – with On-Board DSP

## DESCRIPTION

The **HLA-9P** is a hybrid integration of a nine element J-array loudspeaker and a dipole directional low frequency loudspeaker. It is powered by two internal 750W amplifiers with on-board DSP. The J-array portion contains nine 3.5" mid-frequency drivers and nine ribbon high frequency drivers. The low frequency portion incorporates two 12" high output low frequency drivers in a dipole configuration to extend vertical LF control.

It has been preconfigured in an asymmetrical 35°V by 120°H coverage pattern with vertical directivity to 175 Hz, and low frequency response to 50 Hz. A single HLA-9P can provide full range coverage of both the front row and seats as far as 75 feet away with exceptional clarity and detail.

### KEY FEATURES:

- asymmetrical 35° V x 120° H coverage
- vertical control to 175 Hz
- power & DSP by Powersoft®
- -3 dB low frequency response 50 Hz
- effective projection to 75 feet

### APPLICATIONS:

- churches
- lecture halls
- presentation spaces
- performing arts centers



## NOMINAL DATA

Frequency Response	50 Hz to 20 kHz, ± 3 dB
Power	M/H: 750 W RMS LF: 750 W RMS
Maximum Output	121 dB long-term, 127 dB peak
Nominal Coverage	120° H x 35° V
Dimensions	height: 37.75" / 959 mm width: 15.44" / 392 mm depth: 14.95" / 380 mm
Net Weight	88 lbs / 40.0 kg
Shipping Weight	97 lbs / 44.1 kg

## DESCRIPTIVE DATA

System Configuration	Biamped hybrid integration of a curvilinear M/H line array and a low frequency dipole
Components & Loading	9 x 3.5" MF 9 x 3" ribbon HF 2 x 12" LF drivers
Input	Balanced line level with XLR and XLR loop through
Enclosure Type	Curvilinear array: sealed enclosure Dipole LF: tuned reflex enclosure
Enclosure Material	Steel, Aluminum & Baltic Birch Plywood
Finish	White or Black (custom colors available)
Suspension Hardware	(2) 3/8-16 threaded points on each side; steel yoke included
Grille	Painted perforated steel (fabric-wrap available as an option)



AMERICAN LOUDSPEAKER INNOVATION

Hybrid Line Array Series™ –

**HLA-9P**

**DIMENSIONAL DRAWINGS**

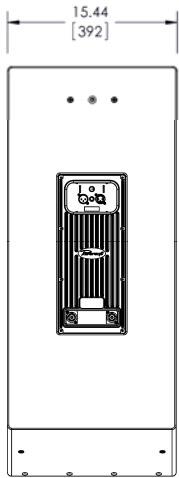

**Back View**

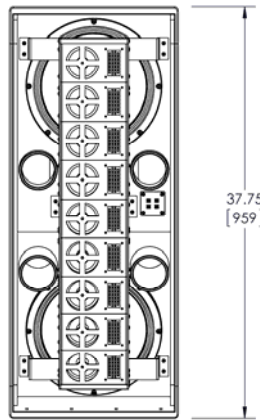

**Front View**

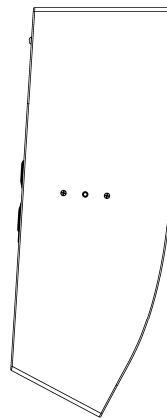

**Side View**

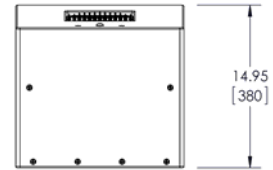

**Top View**

**INCLUDED HARDWARE**

**U-bracket**

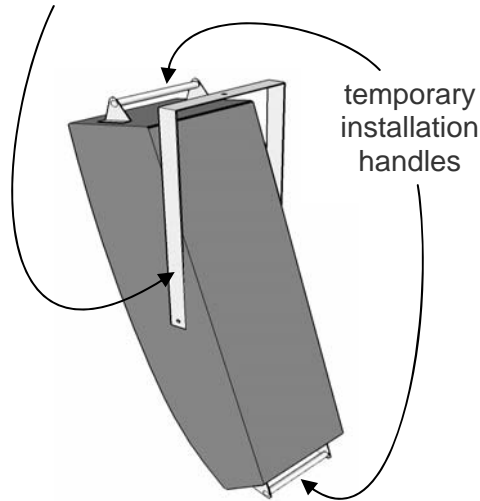

**OPTIONAL ACCESSORIES**

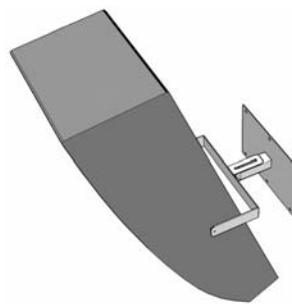

**Wall-Mount  
HLA-9-WM**



**Pole-Mount  
Adapter  
HLA-9-PMA**